



Simple cable–pulley manipulator system for remote translocation of radioactive materials

Janusz Baczyński^{1*}, Michał Baczyński^{2†}

¹ *University of Lodz, Faculty of Physics and Applied Computers Science,
149/153 Pomorska St., 90-236 Łódź, Poland*

² *Technical University of Lodz, Institute of Automatic Control,
18/22 Stefanowskiego St., 90-924 Łódź, Poland*

Abstract

The simple and low cost manipulator system for the use in small workspace of nuclear laboratories is presented. The system is designed for remote translocation of radioactive sources and other applications increasing staff safety during processing of radioisotope materials. The described cable-pulley manipulator is controlled by a very simple PC set-up.

1. Introduction

Radioactive materials (that is, the substances that emit nuclear radiation) are often used for various purposes in different medical or academic research laboratories. It is well known, that the materials can be extremely hazardous to human health or life. The nuclear materials can produce four different kinds of radioactive rays: alpha particles (electrically charged nucleus of a helium atom composed of two protons and two neutrons), beta particles (electrons), neutrons and gamma (short wave-length electromagnetic rays). All kinds of the rays are dangerous for human organisms, of course only when radiation doses

*E-mail address: bacz@uni.lodz.pl

†E-mail address: mbaczyn@p.lodz.pl

are relatively high. Biological results of radiation exposures depend on the dose of absorbed radiation and the type of radioactive particles [1, 2].

The alpha particles are the least penetrating. In practice, the reasonable thin sheet of paper is able to totally absorb the alpha particles - also they are totally stopped by a few centimeters of air.

The beta particles are more penetrating. They can travel a few meters in air or a few millimeters through aluminum before being totally absorbed. In practice, the human skin can stop alpha or beta radiation inside the upper layer of the body tissue.

The gamma rays are the most penetrating. The gamma radioactivity has the same nature as x-rays but it comes from the nucleus and usually the gamma radiation is somewhat higher in energy than x-rays. The gamma rays are able to penetrate large thickness of absorbing material - for example, a few centimeters of lead. Practically, the human body is transparent to the gamma rays.

The conclusion is that, the gamma and beta radiation is the most external danger for workers employed in radioisotope laboratories. Of course, special safety standards and procedures are applied in each laboratory to protect the workers from health hazard. Usually they require exceptionally high accuracy and precision from workers. In such cases there is always a risk of radiation exposing the staff of the laboratory to hazard.

Only the use of automatic or teleoperator systems allows for total elimination of radiation hazardous for staff employed in workspace of nuclear laboratories.

Below the simple cable-pulley manipulator system for small academic research laboratories is presented. To be more specific the system is designed for manipulation of gamma radiation samples in neutron sources. The idea of the described system is that the human operator is physically separated from a place where the manipulation with radiation materials is to be done. For example, a thick lead wall or only a suitably long distance from the radioactivity sources reduces radiation to the absolutely safe level.

2. Manipulators

The manipulator systems have been used in nuclear laboratories since 1940 when the Goertz's group [3, 4] constructed the first one. Since then the manipulators are employed in the places of sources of nuclear radiation in two modes: as off-line automatic systems or for on-line operations. The first one is so called "robot mode". The second one is often called the teleoperation mode. A human operator of the teleoperator system can perform all the risk tasks in real time at a distance, well isolated from the hazardous area.



Fig. 1. 5-DOF robotic arm with the gamma radiation detector – the example of the use of the standard manipulator arm for manipulations in radioactive environments

The teleoperator systems [5]–[7] are especially functional for the remote manipulation in dynamically changing environments where routine procedures (automatically performed) cannot be used.

Regardless of the operation mode used automatic systems or remote controlled systems require proper manipulators for adequate manipulation of radioactive materials in laboratory workspace. The standard solution is the use of a commercially available type robot arm – see Fig. 1.

The basic disadvantage of this approach is that, generally the basis of the arm is not moveable. Thus the workspace of the robotic arm is relatively small. The adaptation of the arm for its relocation in laboratory space requires advanced mechanisms and it is usually very expensive. The use of the cable-driven manipulator [8] can eliminate the substantial disadvantage and the manipulator is relatively simple and low cost.

Thus, it seems that the relatively simple and low cost cable manipulator systems are more adequate for small academic or medical nuclear laboratories.

3. Cable manipulator system

The presented cable-pulley manipulator system designed for small nuclear laboratories consists of a mobile platform and six cables. The cables attached to the platform are pulled by six separate motors that can extend or retract the cables - the schematic form is displayed in Fig. 2.

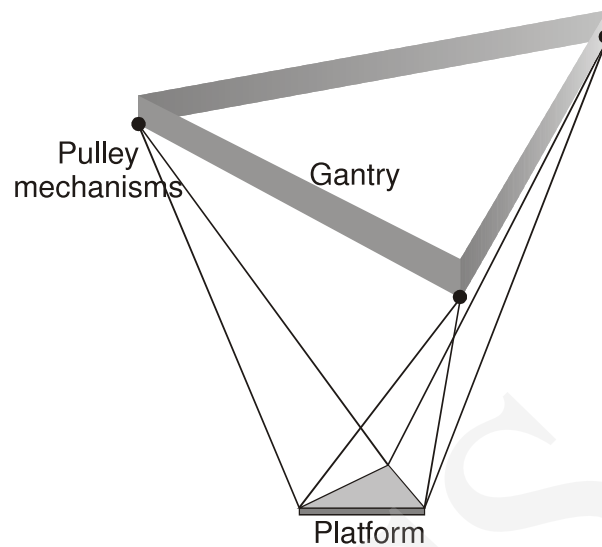

Fig. 2. Simplified scheme of the cable-driven manipulator system

It is similar to NIST RoboCrane® [9]. Practically, the manipulator is a six degrees of freedom inverted Stewart platform [10] which uses gravity to maintain tension in the cable. The cables are attached to pulley mechanisms located in three vertices of an about 4-metre equilateral triangle. In fact the angular points of the triangle are placed on the tetragonal aluminium gantry – the scheme is displayed in Fig. 3. Each vertex contains two pulley mechanisms for two steel cables of a 1.5 mm diameter.

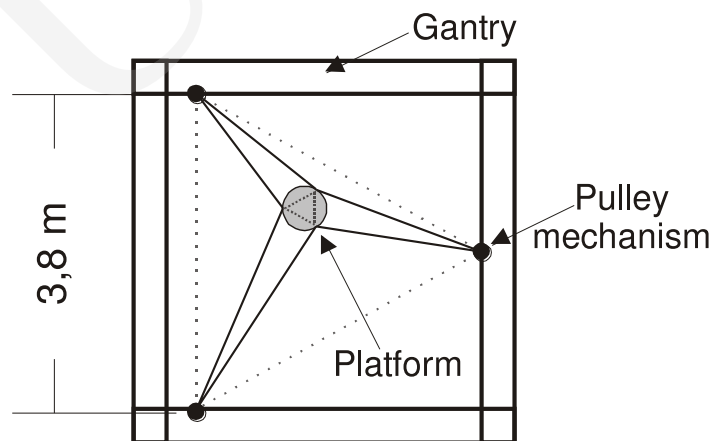

Fig. 3. Axonometric projection of the cable-driven manipulator system

The platform has a form of the circle circumscribed in the equilateral triangle. The cables are attached to the grapples located in the angular points of the triangle.

The construction of the gantry is adapted to install the mobile cable-pulley mechanisms. In this way the layout of the manipulator cables can be changed to adjust it to workspace. Thus the laboratory workspace accessible for the equipment placed on the manipulator platform is about 12 square metres.

The space position and orientation of the manipulator platform can be changed by proper drawing out or reducing the length of the cables. The aligning process is controlled by a PC computer interfaced with the proper control circuit - see Fig. 4. Each of the six pulley mechanisms consists of a winch driven by a separate electric 24V DC motor.

The winches are equipped with incremental encoders to determine changes of the manipulator cable lengths. Each set-up of the motor and the encoder is linked to its separate controller. The controllers are interfaced with the personal computer by the RS-232 serial port. In fact, the controllers are linked to the USB computer port by the standard USB-to-Serial Hub. In this way, employing only one USB port of the PC is enough to control all six cable-pulley mechanisms.

4. Test applications

The cable-pulley manipulator system has been tested for different applications in the university nuclear laboratory. The laboratory is designed for educational purposes. Its relatively small area is like a standard radioisotope laboratory in the medical center.

The cable manipulator can be used for inspection and localization of radioactive impurities in the laboratory workspace. During different manipulations with radioisotopes in nuclear laboratories, the radiation pollution is always possible. For example: hazardous radiation liquid can be spilt on a laboratory desk or single particles of radioactivity powder can be dropped on a floor and so on. Therefore each workday of the laboratory staff includes special procedures for examination of the workspace to detect possible radiation pollution. The procedures require an exceptionally high accuracy and precision and they are usually time-consuming.

The problems can be solved by using the above described cable manipulator system and an additional simple equipment. Fig. 5 shows the work platform of the cable manipulator equipped with a common Geiger-Müller (G-M) detector [11, 12]. The G-M detector is able to detect gamma and beta rays.

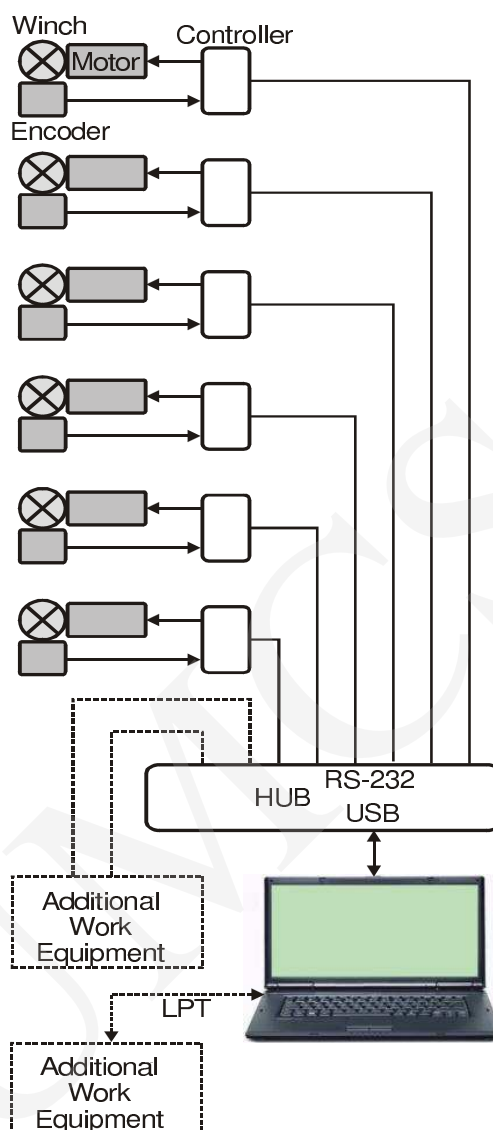

Fig. 4. Electronic system of the cable manipulator

It is absolutely sufficient to detect and localize radioactive pollutions in most radioisotope laboratories.

The G-M detector produces a single pulse for each particle entering its tube. The pulses are counted by an electronic counter interfaced with the PC by the parallel port - see Fig. 4. When the platform with the G-M detector is moved along the monitored surfaces, the PC reads periodically the counter values to determine the radiation rate expressed in counts per fixed time interval.

When the tip of the G-M detector is placed on the gamma source then the registered pulse rate increases largely. It indicates that the system just detects the radiation impurities and the tip of the G-M points on the polluted place. The scanning process of the examined objects can be supervised by the human operator but it can also be automatically performed in a "robot" mode.

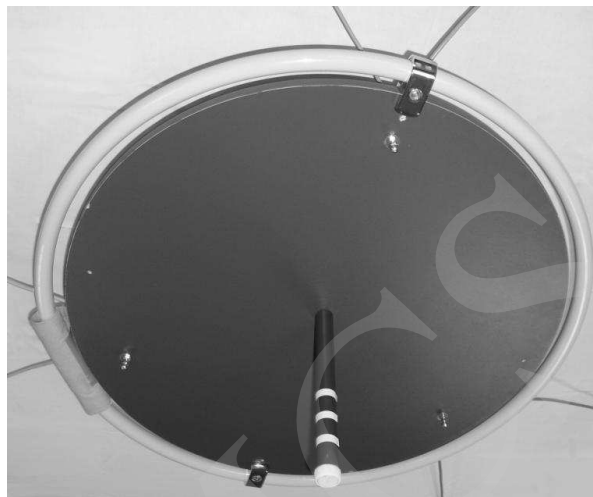

Fig. 5. Work platform of the cable manipulator equipped with the Geiger-Müller detector

Generally, a lot of various operations with radioisotope materials must be performed in nuclear laboratories when they are produced or processed and prepared for further use. They must be often moved between different work places. The action of passing is not always simple since the transferred materials can be strong sources of nuclear radiation threatening health and life of laboratory workers. In those cases, employing the manipulator is the best solution. For those purposes the platform of the presented cable manipulator can be optionally equipped with a low cost end-effector to grasp tiny objects – see Fig. 6. The miniature 5-DOF robot arm is installed on the work platform. The light plastic robot arm is ended by the gripper and its operation reach is up to 35 centimetres. The mass and size of the radiation samples used in academic nuclear laboratories are like common medicine tablets, thus the power lift of the fiddly robotic arm is absolutely enough. The employed robot is a commercially available educational tool called the "ARM-1".

The arm and the gripper are driven by seven analogue servos exactly the same as those applied in hobbyist remote control devices. The servo motors are positioned by the PWM signals generated by the ARM-1 controller accordingly to the commands obtained from the PC by the serial port RS-232 via USB

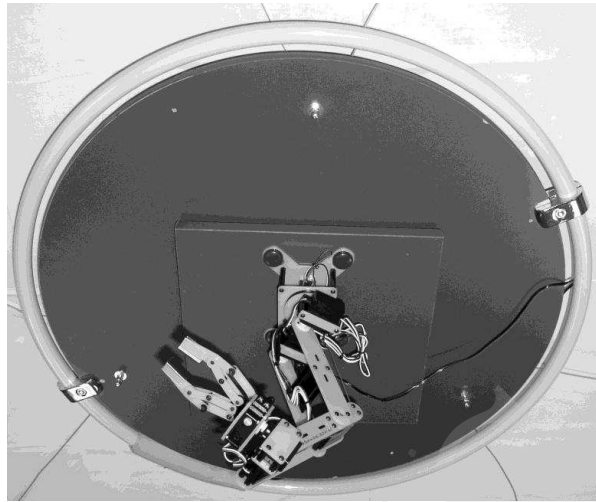

Fig. 6. Educational robotic arm as the end-effector of the cable manipulator

hub - see. Fig. 4. The positioning precision is limited by the unsophisticated servos used. Of course, there are many kinds of manipulations with radioactive substances where higher precision is required. However, the ARM-1 accuracy is absolutely enough to use it as the gripper of the radiation samples for their translocation into laboratory workspace by the cable manipulator.

5. Conclusions

The described cable cable-pulley manipulator system is relatively low-cost and very simple. The two presented applications based show that the manipulator can be very useful in many kinds of nuclear laboratories. The robotic mode allows for saving a lot of work-time of the laboratory staff. In this mode and also in the teleoperator manner the use of the manipulator increases considerably the safety level during works with radioactive materials

Acknowledgment

The presented work has been financed by the Polish State research budget as development project R01 009 03 in the years 2007–2010.

References

- [1] Nias IA. H. W., *An Introduction to Radiobiology*, 2nd. ed., John Wiley & Sons, New York 1998.
- [2] Shleien B., Birky B., *Handbook of Health Physics and Radiological Health*, Lippincott Williams & Wilkins, 1997.

- [3] Goertz R. C., *Fundamentals of General-Purpose Remote Manipulators*, Nucleonics, 10, 11 (1952) 36.
- [4] Goertz R. C., *Manipulators used for handling radioactive materials*, Human Factors in Technology, Chapter 27, Ed. E. M. Bennet, McGraw-Hill, 1963.
- [5] Sheridan T. B., *Telerobotics, Automation and Human Supervisory Control*, MIT Press - 1992.
- [6] Proceedings of the 10th Ann. Symp. on Haptic Interfaces for Virtual Environments and Teleoperator Systems, ASME/IMECE, Orlando - 2002.
- [7] Baczyński J., Baczyński M., *Simple Teleoperator System for Gamma Radiation Decontamination*, Proc. of the ISIE 2005 (IEEE International Symposium on Industrial Electronics), 2005, Dubrovnik Croatia, 20th - 23th June.
- [8] Bosscher P. M., *Disturbance Robustness Measures and Wrench-Feasible Workspace Generation Techniques for Cable-Driven Robots*, Ph.D.Thesis, George W. Woodruff School of Mechanical Engineering Georgia Institute of Technology, November 2004.
- [9] Bostelman R. V., Albus J. S., Dagalakis N. G., *A Robotic Crane System Utilizing the Stewart Platform Configuration*, Proc., ISRAM 1992, Conference, Santa Fe, N.M., Nov. 10-12, 1992.
- [10] Fichter E. F., *A Stewart Platform-Based Manipulator: General Theory and Practical Construction*, Int. J. Robot. Res. 5(2) (1986) 157.
- [11] Glenn F. Knoll, *Radiation Detection and Measurement*, 3rd. ed., John Wiley & Sons, New York 1999.
- [12] Baczyński J., Baczyński M., *Simple robotic system for detecting and marking gamma radiation impurities*, Proc. of the 11th IEEE International Conference on Methods and Models in Automation and Robotics - August 29, 2005 Międzyzdroje.